

Structure of Yeast Regulatory Subunit: A Glimpse into the Evolution of PKA Signaling

Jimena Rinaldi,^{1,4,5} Jian Wu,^{2,4} Jie Yang,^{2,4} Corie Y. Ralston,³ Banumathi Sankaran,³ Silvia Moreno,^{1,*} and Susan S. Taylor^{2,*}

¹Department of Biological Chemistry, Facultad de Ciencias Exactas y Naturales, Universidad de Buenos Aires, Ciudad Universitaria, Pabellón 2, 1428, Buenos Aires, Argentina

²Department of Chemistry/Biochemistry and Pharmacology, Howard Hughes Medical Institute, University of California, San Diego, La Jolla, CA 92093-0654, USA

³Berkeley Center for Structural Biology, Lawrence Berkeley Laboratory, 1 Cyclotron Road, BLDG 6R2100, Berkeley, CA 94720, USA

⁴These authors contributed equally to this work

⁵Present address: Fundacion Instituto Leloir, Av. Patricias Argentinas 435, 1405 Buenos Aires, Argentina

*Correspondence: smoreno@qb.fcen.uba.ar (S.M.), staylor@ucsd.edu (S.S.T.)

DOI 10.1016/j.str.2010.08.013

SUMMARY

The major cAMP receptors in eukaryotes are the regulatory (R) subunits of PKA, an allosteric enzyme conserved in fungi through mammals. While mammals have four R-subunit genes, *Saccharomyces cerevisiae* has only one, Bcy1. To achieve a molecular understanding of PKA activation in yeast and to explore the evolution of cyclic-nucleotide binding (CNB) domains, we solved the structure of cAMP-bound Bcy1(168-416). Surprisingly, the relative orientation of the two CNB domains in Bcy1 is very different from mammalian R-subunits. This quaternary structure is defined primarily by a fungi-specific sequence in the hinge between the α B/ α C helices of the CNB-A domain. The unique interface between the two CNB domains in Bcy1 defines the allosteric mechanism for cooperative activation of PKA by cAMP. Some interface motifs are isoform-specific while others, although conserved, play surprisingly different roles in each R-subunit. Phylogenetic analysis shows that structural differences in Bcy1 are shared by fungi of the subphylum *Saccharomycotina*.

INTRODUCTION

cAMP mediates a wide variety of cellular responses to external stimuli in both prokaryotes and eukaryotes by binding to proteins that contain cAMP binding motifs, which are highly conserved throughout evolution (Berman et al., 2005; Rehmann et al., 2007). In higher eukaryotes, the major receptors for cAMP are the regulatory (R) subunits of cAMP-dependent protein kinase (PKA) (Taylor et al., 1990). Other cAMP receptors include the catabolite gene activator protein (CAP), cyclic-nucleotide gated channels (HCN), and guanine nucleotide exchange proteins (EPAC) (Weber and Steitz, 1987; Zagotta et al., 2003;

Rehmann et al., 2003). In most organisms, PKAs are tetrameric proteins consisting of a regulatory subunit dimer and two catalytic subunits (C). Most R-subunits share the same domain organization that includes a dimerization/docking (D/D) domain at the N terminus and two tandem C-terminal cAMP-binding domains (CNB). The linker joining the D/D and the CNB domains contains an inhibitory site (IS) that resembles a substrate/pseudosubstrate-recognition motif that docks to the active site cleft of the catalytic subunit rendering the holoenzyme inactive (Taylor et al., 2008). There are two major classes of mammalian R-subunits (I and II), and each has α and β isoforms. The four isoforms are products of different genes and functionally nonredundant. Isoform diversity is a primary mechanism for achieving specificity in PKA signaling (Amieux and McKnight, 2002).

In fungi, the PKA holoenzyme also comprises regulatory and catalytic subunits; however, an important difference with mammalian systems is that the majority of fungi, with known genome sequence, has only one R-subunit (*Ascomycetes* and *Basidiomycetes*) (Canaves and Taylor, 2002). Classification and phylogenetic analysis of these R-subunits shows that the fungal R-subunits share the same domain organization as mammalian RI and RII, although they are classified as a separate type (Canaves and Taylor, 2002). Phylogenetic trees indicate that the emergence of multiple paralogous R-subunits occurred late in the evolutionary process, after the divergence of metazoa and fungi. This phenomenon may have occurred in response to the need to maintain a stricter homeostasis and elaborate intercellular communication networks in metazoans. However, by searching through fungal genomes that have recently been released, it was discovered that *Zygomycetes* (*Mucor circinelloides*, *Phycomyces blakesleeanus*, *Rhizopus oryzae*), one of the earlier groups that evolved after the divergence from the proto-eukaryotic organism (Stajich et al., 2009), have several genes coding for functional R-subunits (Ocampo et al., 2009).

The *Ascomycete* *Saccharomyces cerevisiae* belongs to a group of fungi that diverged late in the fungal scale. It is an excellent model to study the basic features of eukaryotes in molecular and cell biology. The cAMP-PKA pathway plays

a major role in this fungus by controlling growth and metabolism in response to nutrients or diverse stress conditions (Rolland et al., 2002; Santangelo, 2006). PKA is the only cyclic nucleotide receptor in this organism. The heterotetramer, R_2C_2 , is formed by two R-subunits, encoded by the Bcy1 gene and two catalytic subunits encoded by three partially redundant TPK1, TPK2, and TPK3 genes (Toda et al., 1987a, 1987b). Although at first sight the primary sequence of Bcy1 suggests that it is structurally and functionally similar to its mammalian counterparts (Johnson et al., 1987), it has been shown to have interesting properties of its own such as nuclear localization (Griffioen and Thevelein, 2002; Tudisca et al., 2010) and lower affinity in its interaction with homologous catalytic subunits (Kuret et al., 1988). Bcy1 also provides a window into the evolution of a classic allosteric enzyme where binding of a small molecule, cAMP, induces a major change in quaternary structure.

Bcy1 exists in two stable conformational states, a cAMP-bound dimer and a C-bound tetramer. To achieve a molecular understanding of the mechanism for activation of PKA by cAMP in yeast and to provide insight into the evolution of the cAMP binding domains in PKA, we purified and crystallized a deletion mutant of Bcy1 bound to cAMP, Bcy1(168-416), and compared it with the mammalian R-subunits. The hallmark that distinguishes the yeast R-subunit from both RII α and RII β (Su et al., 1995; Diller et al., 2001) is the relative orientation of the two CNB domains. Despite excellent superimposition of the individual CNB-A and CNB-B domains in Bcy1, RII α , and RII β , the interdomain interface is dramatically different in each protein, and this creates a unique allosteric signaling network between the two domains. Each protein, Bcy1, RII α , and RII β , uses the conserved cAMP docking site to weave together a distinct interdomain network. The domain interface is correlated with two segments that are conserved in a highly isoform-specific manner, the α B/ α C helix in the CNB-A domain and the α A helix in the CNB-B domain. These motifs, as well as one conserved tyrosine in the PBC, determine the architecture of the domain interface between CNB-A and CNB-B. This analysis of the Bcy1 structure not only provides important insights into the evolution of cAMP signaling but also demonstrates the diversity of cAMP-mediated allostery.

RESULTS

Overall Structure of Bcy1 Is Conserved

Since its discovery, Bcy1 was recognized as the regulatory subunit of cAMP-dependent protein kinase in yeast due to its high sequence similarity to its mammalian counterparts (Toda et al., 1987a). The rationale used in the first step in this study of the Bcy1 structure was to search for a stable fragment containing the two CNB domains, since previous efforts to crystallize full-length dimers of mammalian R-subunits have been unsuccessful while constructs containing only the two CNB domains yielded crystals for structure solutions of both RII α (pdb code: 1RGS) and RII β (pdb code: 1CX4) (Su et al., 1995; Diller et al., 2001). A stability analysis of Bcy1 was therefore undertaken and proteolytic products were analyzed by mass spectrometry (see Figure S1 available online). A stable fragment

Table 1. X-ray Data Collection and Refinement Statistics

Data Collection	
Space group	C2
Cell dimensions	
a (Å)	146.4
b (Å)	45.0
c (Å)	39.1
β (°)	92.5
No. of molecules per asymmetrical unit	1
Resolution (Å)	2.2
R_{sym}^a	0.058 (0.234) ^b
Mosaicity	0.3
Completeness (%)	91.4 (55.5) ^b
I/σ	23.2 (3.8) ^b
No. of unique reflections	12,845
Refinement	
No. of protein residues	246
No. of cAMP ligands	2
No. of water molecules	93
Rmsd from ideality	
Bonds (Å)	0.025
Angles (°)	2.2
R-factor (%)	20.0
R_{free} (%)	26.3
Average B factor (Å ²)	44.6
Ramachandran angles	
Disallowed (%)	0
Most favored (%)	88.1

^a $R_{\text{sym}} = \text{SUM} / \text{ABS} (|I - \langle I \rangle|) / \text{SUM} (I)$.

^b The numbers in the parentheses correspond to the highest resolution shell.

containing the two CNB domains all the way to the C terminus (168-416) was chosen for overexpression and crystallization.

The structure of cAMP bound Bcy1(168-416) was solved to 2.2 Å with a crystallographic R-factor and R-free of 0.20 and 0.26, respectively. Initial phasing was obtained by molecular replacement using the cAMP-bound RII α CNB-A domain (pdb code: 1RGS) as a search model. Data collection and refinement statistics are summarized in Table 1. The refined structure has 246 amino acids, 2 cAMP molecules, and 93 water molecules.

The overall structure of Bcy1(168-416) is similar to the previously solved structures of the corresponding mammalian R-subunit deletion mutants, RII α (91-379) (Su et al., 1995) and RII β (108-412) (Diller et al., 2001). The two tandem cAMP binding domains (CNB-A and CNB-B) assume the conserved fold with one cyclic nucleotide sequestered at each domain (Figure 1). With the N-terminal three residues disordered, the structure starts with residues 171–181 forming the α N helix (following the nomenclature for the mammalian R-subunit structures). The CNB-A structure then continues with the α A helix, the eight stranded β barrel (β 1– β 8), the α B helix, and ends with the α C

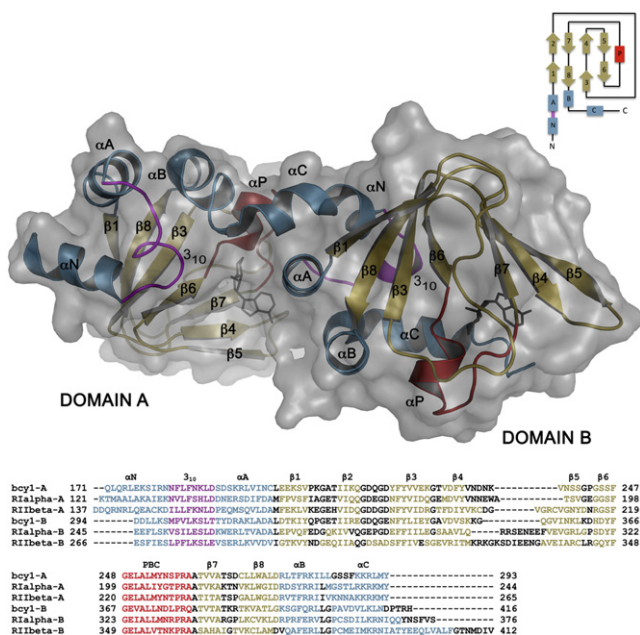

Figure 1. Overall Architecture of Bcy1(168-416) Is Conserved

Structure of Bcy1(168-416) is shown as a ribbon diagram with a transparent space-filling surface (gray). All β strands are in tan and α helices in blue. The 3_{10} loop is highlighted in magenta and the PBC in red. The two cAMP ligands are shown in black sticks. Helices (by capital letters) and strands (by numbers) are labeled periodically to help track the $C\alpha$ trace. The inset shows the general topology of each cAMP binding domain. The lower panel shows the structure-based sequence alignment of CNB-A and CNB-B of Bcy1, R1 α , and R11 β . The color coding is the same as used for the cartoon illustration of the structure.

helix. Similar topology is found for the CNB-B domain (Figure 1). Three important regions are highlighted in Figure 1. One is the phosphate binding cassette (PBC, in red), the hallmark motif for all CNB domains which consists of a short three turn helix and a loop region connecting the $\beta 6$ and $\beta 7$ strands. The phosphate of cAMP and the ribose moiety dock to the PBC. The second is the 3_{10} loop (in magenta) that connects the αN and αA helices, recently identified in mammalian R-subunits as a key signaling switch motif (Kornev et al., 2008). The third is the $\alpha B/\alpha C$ helix which follows β strand 8. While spatial positions of the PBC signature residues and their interactions with cAMP are mostly conserved, the structure reveals unique interactions in Bcy1 that distinguish it clearly from both RI and RII. Details are described below.

Individual CNB Domains Share a Conserved Fold

Individual CNB domains of Bcy1, R1 α , and R11 β superimpose quite well with an average root mean square deviation (rmsd) of $C\alpha$ atoms of 0.9 Å for the CNB-A, and 1.0 Å for CNB-B (Figure 2). Although interaction networks within each CNB domain are highly conserved in Bcy1, RI, and RII, some unique features involving cAMP interactions are also apparent.

According to Kornev et al. (2008), each CNB domain can be viewed as two structural subdomains, a β -barrel subdomain that contains the eight β strands and the embedded PBC motif, and a helical subdomain that contains two noncontiguous

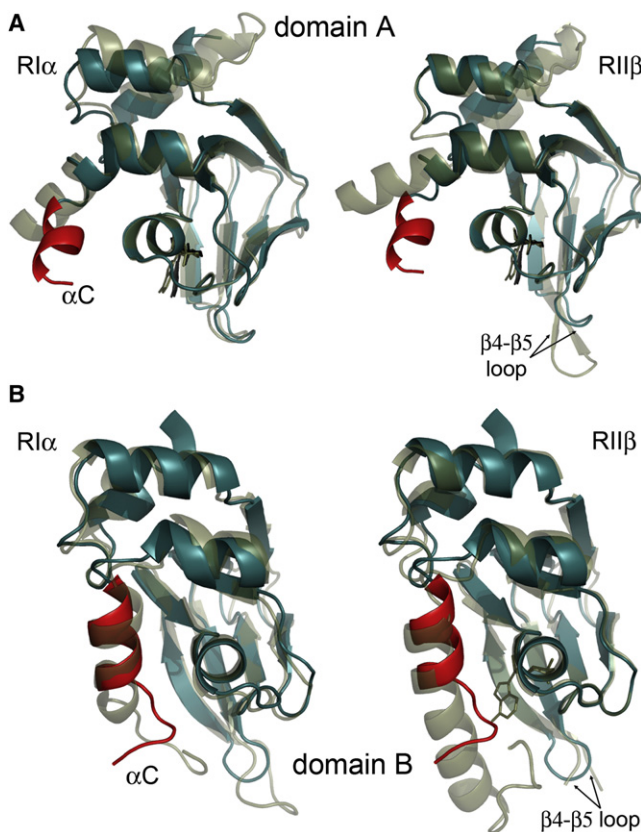

Figure 2. Each cAMP-Binding Domain Adopts a Similar Fold

Each CNB domain is superimposed with the mammalian CNBs. The A domain (A) and B domain (B) of Bcy1 are shown in teal, while R1 α (left) and R11 β (right) are shown in tan with a transparency. αC helices of Bcy1 are highlighted in red.

elements, the αN - 3_{10} - αA (N3A) loop that precedes β strand 1 and the $\alpha B/\alpha C$ helix that follows β strand 8 (Figures 1 and 2). The β -barrel subdomain, which senses and docks cAMP, is relatively rigid while the helical subdomain is highly flexible when the cAMP-bound conformation is compared with the holoenzyme conformation in both RI and RII (Kim et al., 2005, 2007; Wu et al., 2007; Brown et al., 2009). In this structure of Bcy1, we see how binding of cAMP creates a unique extended interface between the two CNB domains that is distinct from R1 α and R11 β . This interface is destroyed in the holoenzyme when the R-subunit releases cAMP and binds to the C-subunit. The differential intrinsic flexibility of the subdomains appears to be maintained in Bcy1 in that its helical subdomain exhibited a 1.6-fold higher average temperature factor relative to its β -barrel subdomain. Structural alignment also shows a better superimposition in the β -barrel subdomains of Bcy1, R1 α , and R11 β , while most variances occur in the helical subdomains (Figure 2).

The $\alpha B/\alpha C$ helix in the CNB-A domain is the most dynamic part of the molecule. In the mammalian holoenzyme structures, this helix extends into a single long helix that docks onto the catalytic subunit (Kim et al., 2005, 2007; Wu et al., 2007; Brown et al., 2009) while in the cAMP bound conformations the $\alpha B/\alpha C$ helix is recruited to the PBC (Su et al., 1995; Diller et al., 2001).

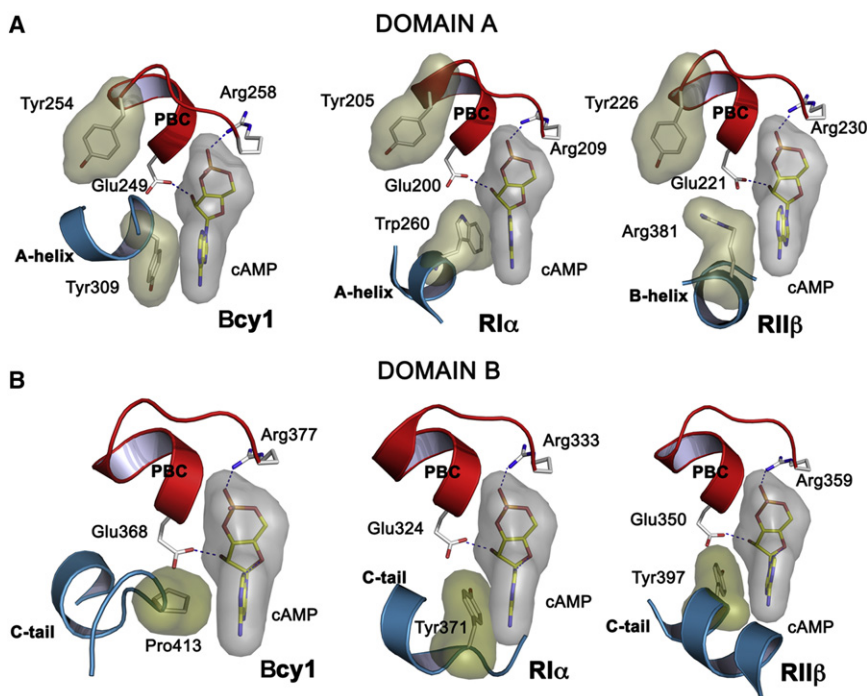

Figure 3. General Fold of the PBCs in Bcy1 Is Conserved; Capping Residue in CNB-B Differs

PBC (in red) is the signature motif for the cAMP binding, with the highly conserved Glu and Arg residues. The cAMP and its capping residues are shown in the shadowed space-filling surface. The A domain (A) capping residues are all from the B domain. Bcy1 has a Pro as its capping residue in its B domain (B), differing from the mammalian R-subunits.

Arg258^{Bcy1} makes similar interactions with the phosphate oxygen of cAMP as did Arg209^{RI} from RI α and Arg230^{RII} from RII β , while the hydrogen bond interactions of Glu249^{Bcy1} with the cAMP ribose 2'-OH are analogous to the ones of Glu200^{RI} and Glu221^{RII} (Figure 3A). The same pair of interactions are conserved in CNB-B for Arg377^{Bcy1} (Arg333^{RI}, Arg359^{RII}) and Glu368^{Bcy1} (Glu324^{RI}, Glu350^{RII}) (Figure 3B).

While docking of cAMP to the PBC is conserved in each CNB domain, two features distinguish each of the isoforms

In the CNB-A domain of Bcy1 the α C helix bends in a different direction compared with RI α and RII β , and this creates not only a unique global conformation but also a distinct interface between the two CNB domains. In the CNB-B domain the α C helix is also distinct in Bcy1 because it is shorter although it has the same orientation as the longer ones in RI or RII (Figure 2B). The shortness of the α C helix is shared only by the *Saccharomycotina subphylum* in the fungal alignment (Figure S2).

Another motif that appears to have evolved differently in each CNB domain is the β 4- β 5 region. Overall sequence alignment shows more than 40% identity between the CNB domains of Bcy1 and RI α /RII β ; however, one region that shows major sequence divergence occurs at β strands 4 and 5 and their connecting loop (Figure 1, lower panel). Sequence alignment of R-subunits from fungi and mammals (Figure S2) indicates that this region is variable in both length and primary sequence. In Bcy1, as well as in all the *Saccharomycotina* paralogs, the β 4- β 5 strands and the intervening loop are shorter in both CNB domains, as highlighted in the superimposed structures (Figure 2).

PBC Motif Is Conserved

Earlier structural and bioinformatic studies suggested that the PBC motif is highly conserved in R-subunits from all species (Canaves and Taylor, 2002). Each PBC contains two essential charged residues within a structurally conserved hydrophobic environment and a short phosphate binding helix. Conserved features of the PBC include a buried arginine that binds the exocyclic phosphate of cAMP and a glutamic acid that binds the ribose 2'-OH. The structures of the PBC and these landmark residues are highly conserved in Bcy1 (Figure 3). In CNB-A,

and also the A and B domains. One is the hydrophobic residue that caps the adenine ring of cAMP (Berman et al., 2005). The other is the interdomain interactions that radiate outward from the PBC in the CNB-A domain to the CNB-B domain. These are described in the following sections.

Relative Orientation of the Two CNB Domains Is Unique in Bcy1

The different orientation of the two CNB domains is the most striking feature of the Bcy1 structure that distinguishes it from RI α and RII β , and this is due to the unique positioning of the α C helix in the CNB-A domain. This difference is seen most clearly when the CNB-A domain of Bcy1 is superimposed with the CNB-A domains of RI α or RII β . As seen in Figure 4A, their CNB-B domains exhibit significant displacement.

A close look at the alignment shows that the structures start to diverge at the kink or hinge region (²⁸⁴GSSF²⁸⁷) between the α B and α C helices in CNB-A (Figure 4B). This hinge segment is conserved uniquely in each R-subunit and is clearly a dynamic switch region since in the mammalian holoenzymes the α B/ α C helices extend into a single long helix that is buttressed up against the catalytic subunit. Two interactions at this divergence point may account for the unique orientation of the two domains in Bcy1. Phe287 from the CNB-A α C helix forms hydrophobic interactions with Phe183 and Leu184 from the 3₁₀ loop (Figure 4C). This contact reinforces interactions between the two noncontiguous helical subdomains. Another contact is the hydrogen bond interaction between Ser285 from α C and Lys187 from the same 3₁₀ loop (Figure 4C). Interestingly, these two interactions of the 3₁₀ loop with α C are missing in both RI α (91-379) and RII β (108-402). As indicated in the sequence alignment, both Phe183 and

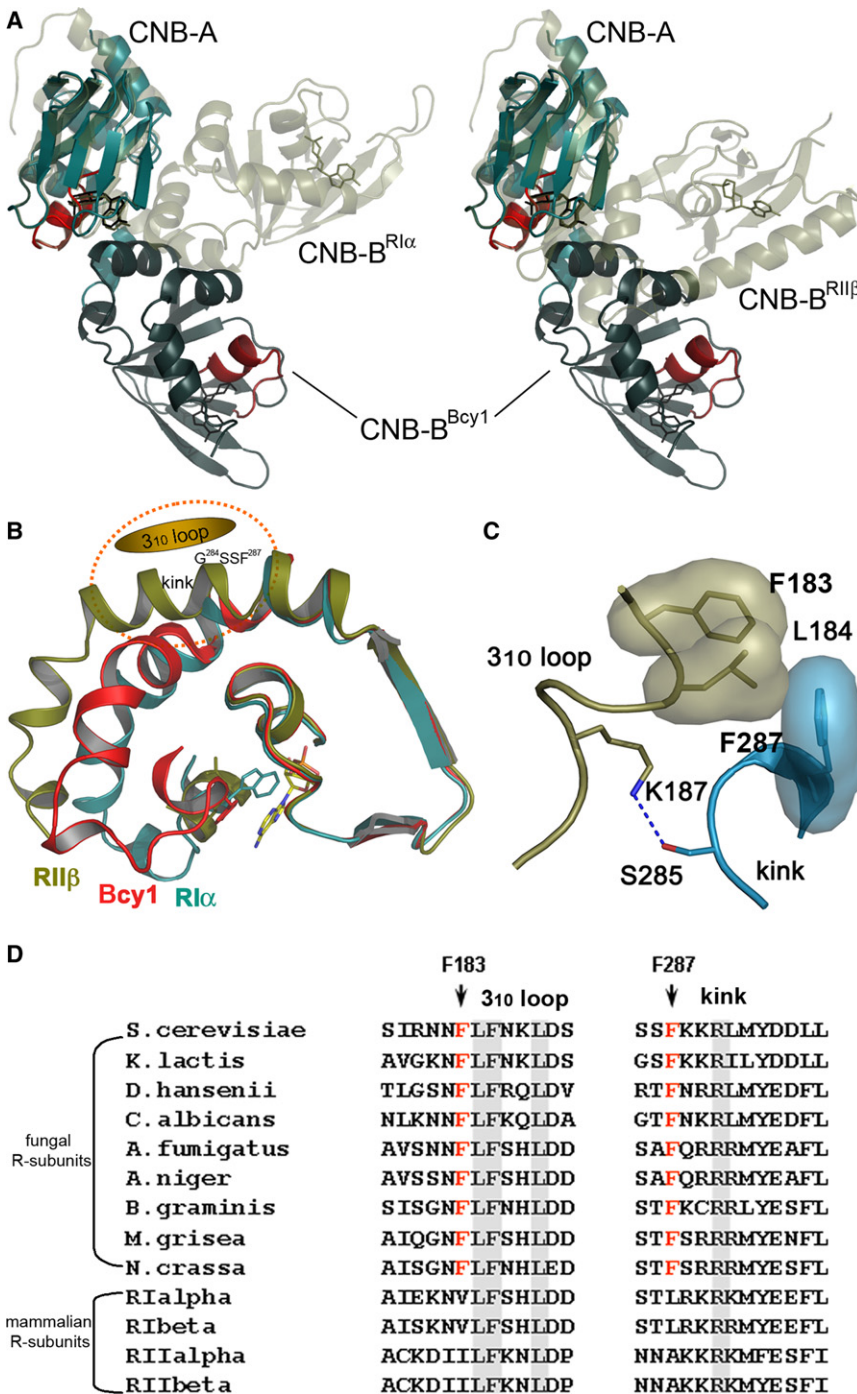

Figure 4. Bcy1 Assumes a Very Different Interdomain Orientation Compared with the Mammalian R-Subunits

(A) Superimposition of Bcy1 (A domain in teal; B domain in dark teal) with R1 α (tan, left) and R1 β (tan, right), respectively, indicate that the relative position between the A and B domain in Bcy1 is significantly different compared with the two mammalian isoforms. Both R1 α and R1 β are shown by a transparency. The Bcy1 PBCs are shown in red. (B) Superimposition of PBCs and B/C helices of Bcy1 (red), R1 α (cyan) and R1 β (tan). The structures start to diverge at the α C helix of CNB-A, specifically at the kink region of ²⁸⁴GSSF²⁸⁷. (C) Detailed interaction between this kink region (cyan) and the 3₁₀ loop (tan). (D) Sequence conservation at hinge points, with Phe183 and Phe287 highly conserved in fungal R-subunits but not in mammalian R-subunits.

cAMP Interaction Network for CNB-A Involves Both Intradomain and Interdomain Contacts

Although the PBC provides the primary docking site for cAMP in the CNB-A domain, several important contacts are made to the CNB-B domain, and these likely contribute to the cooperativity in activation by cAMP. In this way docking of cAMP to CNB-A radiates throughout the molecule (Das et al., 2007; McNicholl et al., 2010). Two tyrosine residues contribute prominently to the interdomain network, Tyr309 in the α A helix of CNB-B and Tyr254 at the tip of the PBC in CNB-A.

The CNB-A domain is unique compared with the CNB-B domain and CAP in that the capping residue for the adenine ring of cAMP comes from the CNB-B domain and not from the CNB-A domain itself (Berman et al., 2005). This capping residue is thus an important interdomain contact for CNB-A. In the case of Bcy1 and R1 α , the capping residue is located in the α A^B helix (superscript B refers to CNB-B), while in R1 β , the capping residue lies in the α B^B helix (Figure 5A). These interdomain contacts appear to play a key role mediating the cooperative binding of cAMP to the two domains.

Phe287 are unique to Bcy1. Phe287 is conserved in all fungal R-subunits examined, while Phe183 is conserved in the majority of *Ascomycetes* (Figure 4D; Figure S2). In contrast, the residues at the corresponding positions are not conserved in the mammalian R-subunits (Val and Leu for RI, and Ile and Ala for RII), and they do not form a hydrophobic packing similar to what we see in Bcy1 (Figure 4C). This strict conservation of the two phenylalanines in Bcy1 and other fungi is unique to CNB-A, and is not found in CNB-B.

Although the relative orientation of the two CNB domains in Bcy1 is quite different from the mammalian R-subunits (Figure 4), its α A^B helix is juxtapositioned up against the CNB-A domain in a manner that is similar to the α A^B in R1 α (Figure 5). As a result, the side chains of several key residues are at similar positions in Bcy1 and R1 α . Specifically, Tyr309^{Bcy1}, with its aromatic ring packed against the adenine ring, provides the hydrophobic cap for cAMP^A, similar to Trp260^{RI} in R1 α (Figures 3 and 5). In contrast, for R1 β , it is Arg381^{RII} in the α B helix of CNB-B that serves as the

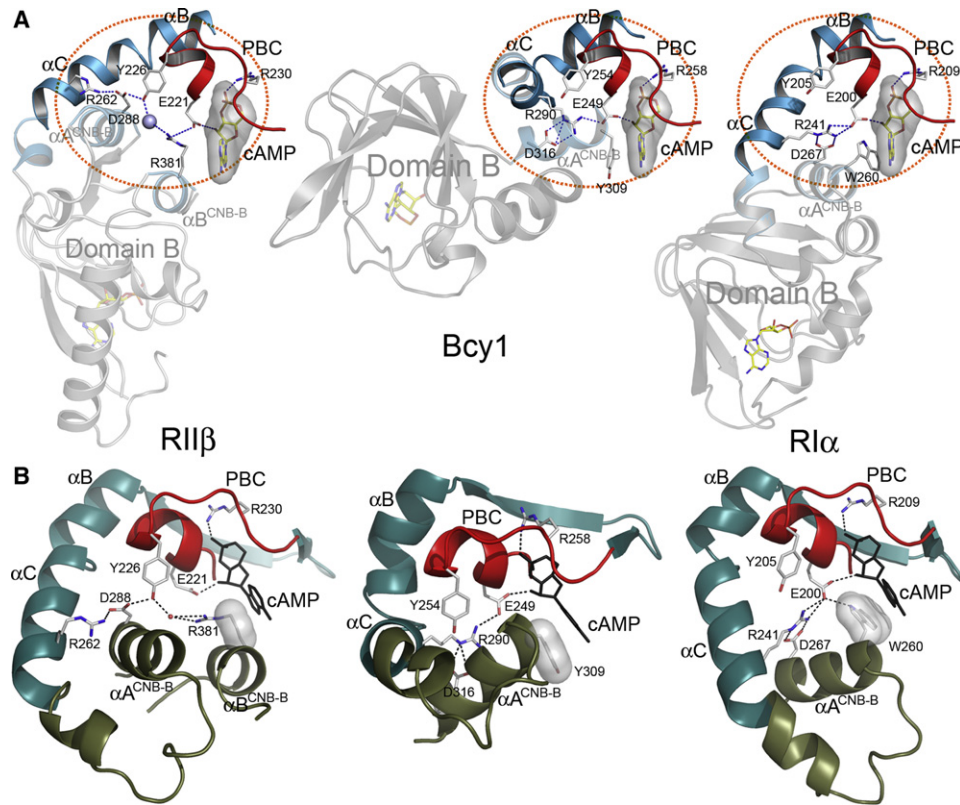

Figure 5. Interface between the A and B Domains Has Unique Characteristics

(A) The interdomain H-bond network of Bcy1 (middle) is similar to RI α (right) but not RII β (left). Like in RI α , the conserved Glu249 is stabilized by the same hydrogen-bonding network which links the A and B domains, although the main chains of those residues are in very different positions. The PBCs are shown in red with cAMP in a space-filling format. The positions of CNB-B are shown by a transparency. (B) A zoom-in view of the interdomain interactions, circled (golden) in (A).

capping residue for cAMP^A. Immediately preceding the capping residue is Thr308, and another unique characteristic of Bcy1 is also seen in the indirect interaction of Thr308^{Bcy1} from α^B with cAMP^A through a conserved water molecule that interacts with one of the exocyclic phosphate oxygen of cAMP (Wu et al., 2004) (Figure 6). These two residues thus are anchored to both ends of

the cAMP molecule when bound to CNB-A, and this is unique to Bcy1. Although conserved in the three R-subunits, this stable water molecule does not interact with a residue from the CNB-B domain in RI α or RII β ; instead, it is secured by Thr207 in the PBC.

Another example of similarity with RI α is the network of hydrogen bonds that mediate the interaction of Glu249^{Bcy1}

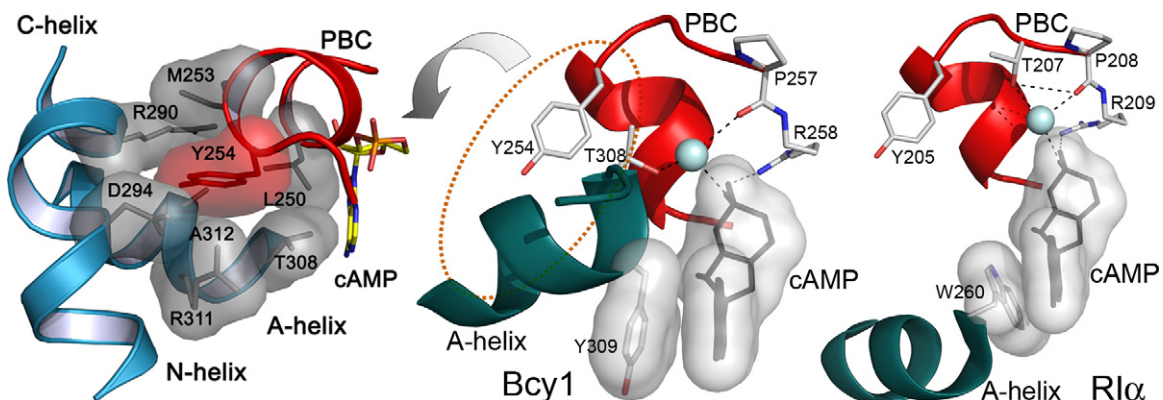

Figure 6. Unique cAMP-Binding Characteristics of CNB-A in Bcy1

A water molecule in the cAMP binding pocket of CNB-A in Bcy1 (middle), compared with RI α (right). Tyr254 from the tip of PBC is in a hydrophobic pocket in Bcy1 (zoomed and reoriented in the left). However, the equivalent residue, Tyr205, is solvent-exposed in RI α (right).

(Glu200^{RI}) from the PBC with the ribose 2'-OH of the CNB-A cAMP. This includes two key residues, Asp316^{Bcy1} in the α A helix of CNB-B and Arg290^{Bcy1} in the α C helix of CNB-A (equivalent to Asp267^{RI} and Arg241^{RI}) (Figure 5). For RII β , although those equivalent key residues are present, the interaction network is very different from that of Bcy1 and RI α (Figure 5). This hydrogen-bonding network also interacts in unique ways with Tyr254, which is located at the tip of the PBC and conserved in all three R-subunits (Tyr205^{RI}, Tyr226^{RII}). This Tyr plays an important role in docking to the C-subunit for both RI and RII (Kim et al., 2005, 2007; Wu et al., 2007; Brown et al., 2009); however, its role in the cAMP bound conformation, is distinct in each R-subunit. In Bcy1 Tyr254^{Bcy1} provides another unique interdomain contact since its aromatic ring is tightly secured in a hydrophobic pocket that is formed by residues from the α A^B helix. This entire surface of the α A^B helix is thus anchored to the CNB-A domain by a set of Bcy1 specific interactions that include both electrostatic/hydrogen-bonding contacts and hydrophobic interactions. As shown in Figure 6, Arg311^{Bcy1} and Thr308^{Bcy1} are both part of the hydrophobic pocket, where Tyr254^{Bcy1} is snugly buried. This hydrophobic interaction is unique in Bcy1. In RI α , the corresponding Tyr205^{RI} is solvent exposed and does not make any contacts with other residues, whereas in RII β , the corresponding Tyr226^{RII} makes two hydrogen bond interactions, one with Asp288^{RII} in the CNB-B domain (Asp316^{Bcy1}, Asp267^{RI}) and one with a water molecule that connects to the capping residue Arg381^{RII} from the α B^B helix (Figure 5). Thus it also links directly to the CNB-B domain but in a completely different way. In RI α , RII α , and RII β holoenzymes (Kim et al., 2005, 2007; Wu et al., 2007; Brown et al., 2009), this tyrosine interacts directly with the P+1 hydrophobic residue in the inhibitor peptide that is docked to the active site cleft of the catalytic subunit in the holoenzyme.

cAMP Capping in the CNB-B Domain of Bcy1 Is Also Distinct

Similar to RI α , RII β , and CAP, residues that interact with cAMP in the CNB-B domain of Bcy1 come from the B domain. Most of the interaction network is conserved in Bcy1, RI, and RII, except for the capping residue itself. Instead of a tyrosine (Y371^{RI}, Y397^{RII}) packing against the adenine ring of cAMP, Bcy1 has a proline (Pro413) that serves as the capping residue for cAMP (Figure 3B). The aliphatic ring of this proline is engaged with the aromatic adenine ring of cAMP, leading to a C-H/ π interaction with the most commonly found geometry (Bhattacharyya and Chakrabarti, 2003) with the edge of the proline interacting with the face of the aromatic ring (Figure 3B). This type of capping residue for the cAMP in CNB-B domain seems to be conserved in many fungal R-subunits, which share with Bcy1 the shorter C terminus and an equivalent proline in CNB-B. This difference in capping may have an impact on the biochemical properties of cAMP bound to B domain and likely accounts, at least in part, for Bcy1's unique analog specificity (P. Jacobo, P. Portela, and S.M., unpublished data).

The Structure of Bcy1 Is Representative of the Subphylum *Saccharomycotina*

The members of the PKA-R family have been analyzed by multiple sequence alignment and clustering based on phyloge-

netic tree construction (Canaves and Taylor, 2002). From this work, it was evident that the fungal R-subunits constitute a separate category, different from RI, RII, and alveolate R-subunits. The alignment included 10 fungal sequences that were available at that time. We have now used a method of contrast hierarchical analysis, CHAIN (Neuwald, 2007) to align 40 R sequences from fungi and 65 from mammals (Figure S2). The alignment included the IS region, through the two CNB domains (starting from residue 133 of Bcy1). To evaluate whether the different structural characteristics of Bcy1 were shared by other fungal sequences, we inspected the alignment looking for the following features: (1) conservation of the Phe183 in the 3₁₀ loop and Phe287 in the kink region; (2) putative capping residue for the CNB-B domain; (3) length of the C terminus; and (4) length of the β 4– β 5 loop. From the results shown in Table 2, it is evident that all of the differential features of Bcy1 are shared by an important group of fungi which belongs to the subphylum *Saccharomycotina* including the genus *Candida*. The *Pezizomycotina* subphylum is the only other group that shares with the *Saccharomycotina* the two Phe residues, important for the unique orientation of the CNB-A and CNB-B domains in Bcy1. It is not possible to predict the capping residue for CNB-B in *Pezizomycotina*, although there is a conserved Tyr as in RI and RII, there is also a Pro in a primary context sequence similar to Bcy1. The other fungi have a longer C terminus and, instead of a Pro, they have a conserved Tyr, which is very likely used as the capping residue for CNB-B. The β 4 and β 5 strands as well as their intervening loop are also conserved within each group of fungi but vary in length and sequence. From the cAMP-bound and holoenzyme conformations solved to date, we do not know why there is this strict conservation of the β 4– β 5 loop. Most likely it will correlate with the full-length tetrameric holoenzymes. In order to analyze the phylogenetic relationship of the fungal sequences compared with mammalian R-subunits, we selected representative sequences from the CHAIN alignment, to construct a radial phylogenetic tree using only the CNB domain sequences of these proteins (Figure 7). It is very interesting that the clusters assembled from this tree correspond to the groups of fungi classified according to the conservation of the Bcy1 structural characteristics, which is shown in Table 2. This result suggests that each cluster corresponds to a structurally different R-subunit.

DISCUSSION

PKA is a classic allosteric enzyme where binding of a small molecule, cAMP, dramatically alters the quaternary structure in a way that leads to activation of the kinase. Although the structure of Bcy1 shows that the overall architecture and general cAMP binding features of the yeast R-subunit are similar to its mammalian counterparts (Figures 1–3), the structure also reveals some hallmark features that differentiates it, and probably the whole subphylum *Saccharomycotina* group, from the mammalian R-subunits (Figures 4 and 5). The most striking hallmark feature of Bcy1 is the unique orientation of the two CNB domains relative to each other. This tightly packed surface is created by cAMP binding to the two CNB domains, while in the holoenzyme this interface is destroyed and replaced by a new set of interactions with the catalytic subunit. Given the high degree of sequence conservation, the extended allosteric network between the two

Table 2. Structural Classification of Fungal and Mammalian R-Subunit Sequences

Phylum	Subphylum ^a	Group ^b	F183 ₃₁₀ Loop	F287 Kink	Cap CNB-B	C-t Length	β4–β5 Loop Length A–B
Kingdom: fungi							
Ascomycota	Saccharomycotina (11)	I	+	+	P	S	S–S
Ascomycota	Pezizomycotina (19)	II	+	+	P/Y	S	L–S
Ascomycota	Taphrinomycotina (1)	III	+	–	Y	L	S–S
Basidiomycota	Ustilaginomycotina (2) Agaricomycotina (4)	IV	+	–	Y	L	L–L
Zygomycota ^c	Mucoromycotina (5)	V	+	–	Y	L	S–S
Blastocladiomycota (1)		V	+	–	Y	M	L–L
Kingdom: metazoa							
	Mammalia RI (30)	VI	–	–	Y	L	S–L
	Mammalia RII (33)	VI	–	–	Y	L	L–L

Fungal and mammalian sequences summarized in Table S1 were visually inspected from Figure S1 and classified in groups according to the number of the following structural properties they shared with the Bcy1 sequence: presence of a F (equivalent to F183 in Bcy1) in the 3₁₀ loop; presence of a F (equivalent to F287 in Bcy1) in the kink domain; type of putative cap residue in CNB-B (proline P or tyrosine Y); length of the C terminus of CNB-B, defined as short (S), medium (M), or large (L); global length of the β4–β5 loop computed for domain CNB-A (A, left) and CNB-B (B, right).

^a Numbers between brackets represent the number of sequences analyzed for each subphylum.

^b The numbering of the groups in fungi, go from I to V from sequences that diverged more recently to the oldest; however, some of the subphylla within the groups diverged almost simultaneously.

^c Zygomycota phylum is at present renamed as “basal fungal lineages.”

CNB domains is surprisingly different in each R-subunit. Some motifs at the interface are highly isoform-specific while others, though conserved, play different roles in each structure (Figure 8). Overall Bcy1 appears to be a hybrid between RI and RII. Sequence-wise, it is similar to RII as it has a phosphoacceptor Ser at the inhibitory/substrate site. Structurally, however, Bcy1 is more similar to RI α in many regards (Figure 5). Bcy1 also exhibits several striking features that are unique to the yeast protein (Figures 3–5). Together with bioinformatics analysis, the structure of Bcy1 sheds new light on our understanding of how the binding and activation of PKA by cAMP has evolved from lower to higher eukaryotes. It thus provides a unique window into the evolution of allostery.

cAMP Binding to the CNB-A Domain Drives the Allosteric Switching

Structures of RI α and RII β (Su et al., 1995; Diller et al., 2001) demonstrated how in the presence of cAMP the two tandem CNB domains come together to create a complex and asymmetric interface while in the absence of cAMP the CNB domains come apart and create an extended interface with the catalytic subunit. These changes, which define the allosteric regulation of PKA, are driven primarily by the helical subdomains of CNB-A, which interact with either the catalytic subunit or the CNB-B domain. In each CNB domain, the two noncontiguous helical motifs (N3A and α B/ α C) respond directly to cAMP binding with the α B/ α C helix moving “in” toward the PBC and the N3A motif moving away from the PBC. Common motifs, as well as isoform-specific motifs, localized mostly in the CNB-A domain, drive these changes, and the interface is actually quite different for all three R-subunits. In each R-subunit the interface is quite complex and involves both intradomain and interdomain interactions (Figure 8), whereas the interaction network for cAMP in CNB-B is more simple and comes mostly from within the B

domain (Figure 3). Across species, more divergence is also observed in the CNB-A domain while CNB-B exhibits fewer variations (Canaves and Taylor, 2002). Differences in the two CNB domains are also reflected in the mammalian holoenzymes. Recently solved R:C complexes show that the CNB-A domain is more directly involved in the R:C interface interactions, whereas the CNB-B domain is more loosely associated with the C-subunit and more accessible to cAMP.

Further evidence to support the unique importance of CNB-A is that several residues that play key roles in interacting with cAMP, or in defining the species-specific features of each R-subunit, are only conserved in CNB-A. For example, the Phe183^{Bcy1} from the 3₁₀ loop and Phe287^{Bcy1} from the kink region in the α B/ α C helix form a key hydrophobic interaction that determines the orientation of the α B/ α C helix which in turn defines the unique orientation of the two domains. Both Phe183^{Bcy1} and Phe287^{Bcy1} are highly conserved in the Ascomycetes, but different in their mammalian counterparts. These CNB-A motifs are not conserved in CNB-B. Another key residue that contributes to the R:C interface is the tyrosine in the PBC of the CNB-A domain (Tyr205^{RI}, Tyr226^{RII}, Tyr254^{Bcy1}). This Tyr is missing in CNB-B domains. Although the Tyr is conserved, the way that it interacts with the CNB-B domain is different in each R-subunit (Figure 8). Thus, even though many residues are conserved, the details of how each contributes to the extended interface are surprisingly different.

Conserved Interdomain Interactions Are Used to Convey Cooperativity

Kinetic, crystallographic and more recently NMR data (Das et al., 2007; McNicholl et al., 2010) have illustrated the cooperative binding of cAMP to the two CNB domains in RI and RII, and the involvement of interdomain interactions that radiate out from cAMP bound to CNB-A provides a molecular mechanism

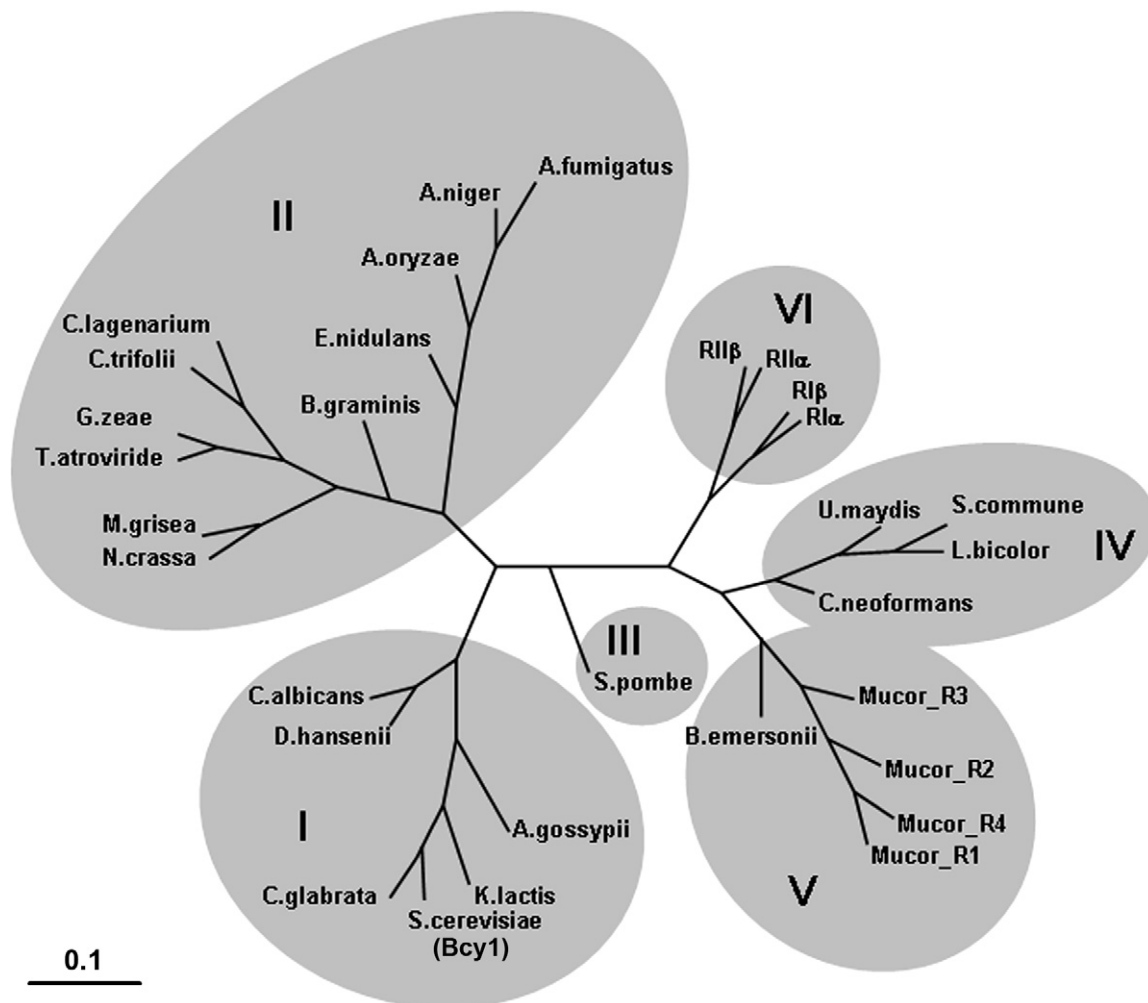

Figure 7. Phylogenetic and Structural Clusters Are Alike

A radial phylogenetic tree was constructed with representatives of the different suphylla of fungal R-subunits with mammalian isoforms. Analysis was performed using the neighbor-joining algorithm. The tree is based on the sequence alignment of the A-B domains indicated in Table S1 with an asterisk. Clustering patterns are shaded in gray. Roman numbers are assigned to groups according to the structural classification defined in Table 2. Phylogenetic distance is approximately proportional to branch length. A bar for calibration of phylogenetic distances is provided at the bottom. See also Figure S2.

for this cooperativity in PKA activation. We find again that this theme is applicable to a simpler eukaryote like Bcy1. In general, Bcy1 shares an interaction network more similar to RI α than to RII β . In RII β , for example, both α^A and α^B from CNB-B contribute to the interdomain interaction, with the cAMP capping residue (Arg381^{RII}) coming from the α^B helix, whereas in Bcy1 and RI α the α^A helix from CNB-B provides the capping residue (Tyr309^{Bcy1}, Trp260^{RI}) (Figure 5). The capping residue in RI α and Bcy1 is at the N terminus of the α^A helix while at the C terminus is a conserved aspartate (Asp316^{Bcy1}, Asp267^{RI}, Asp288^{RII}) that hydrogen bonds directly to Arg290^{Bcy1} in the α^C helix, and this electrostatic interaction is conserved in all of the R-subunits and also in the holoenzyme. This ion pair also participates in a hydrogen-bond network with the highly conserved glutamate (Glu249^{Bcy1}, Glu200^{RI}, Glu221^{RII}) from the PBC, which interacts with the 2'-OH of cAMP (Figure 5). This link to the PBC glutamate is conserved in Bcy1 and RI α , but different in RII β . The intricate

interaction between the two domains is consistent with the cooperative binding of two cAMP molecules to Bcy1, which has been already suggested genetically (Portela et al., 2001) and kinetically (P. Jacobo, P. Portela, and S.M. et al., unpublished data).

Interacting Helical Motifs Define the Allosteric Switches

In considering the allosteric mechanism that allows cAMP to destroy the extended interface between the R- and C-subunits and then create an equally complex and extended network between the two cyclic nucleotide binding domains, two helices (the α^A/α^C helix and the α^B helix) are essential for the quaternary structure changes yet conserved uniquely in each R-subunit (Figure 8). Embedded within these two helices are the motifs that define how the different parts of the CNB-A and CNB-B domains are docked to each other. The α^B/α^C helix in CNB-A is the dynamic switch that toggles between its extended conformation

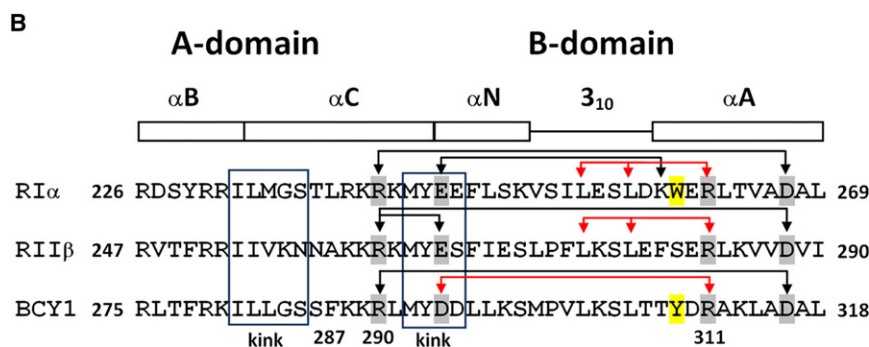
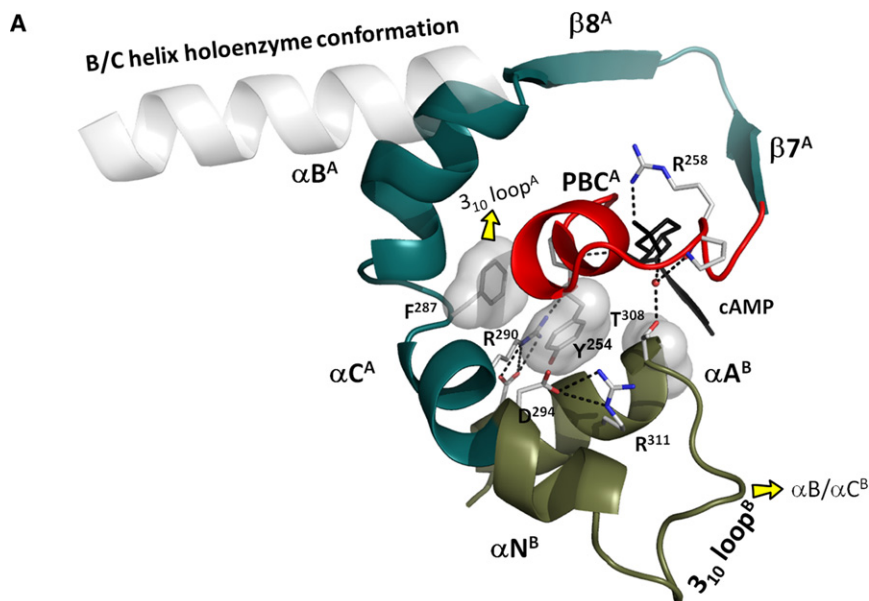

in the holoenzyme and its kinked conformation in the cAMP-bound state. While we do not have a structure of Bcy1 bound to a catalytic subunit yet, analysis of the sequences suggests that the holoenzymes will all, in general, be similar. The α A helix in the B domain is the other element that appears to be unique. In all cases this helix is firmly anchored to the CNB-A domain. However, how it bridges to the CNB-A domain is variable and highly specific to each protein.

In Bcy1, we see how the entire exposed surface of the α A helix is used to dock both directly and indirectly to cAMP that is bound to the CNB-A domain. At the N terminus is the capping residue, discussed above, Tyr309^{Bcy1}. Immediately preceding Tyr309 is Thr308, and its hydroxyl side chain interacts with a water molecule that bridges to the exocyclic oxygen of cAMP (Figure 6). These two residues at the beginning of the α A^B helix thus anchor the helix to both ends of the cAMP that is bound to the CNB-A domain and is unique to Bcy1. In RI α and RII β there is also a stable water molecule but it is bound to Thr207^{RI} in the PBC. In Bcy1 this Thr is a Ser. At the other end of the α A^B helix is the conserved electrostatic interaction, discussed above, that anchors the α A^B helix to the α C^A helix in CNB-A. This electrostatic interaction between Asp267 and Arg241 is conserved in all of the R-subunits.

which this tyrosine contributes to the interface between the CNB-A and CNB-B domains is different in each R-subunit, this interface is completely destroyed in each holoenzyme when the α B/ α C helix extends into a single long helix that docks onto the catalytic subunit. The essential residues for docking onto the C-subunit in the holoenzyme are conserved in each R-subunit. We thus speculate that since this tyrosine is another conserved feature of the PBC in all CNB-A domains, it likely plays a conserved role in formation of the holoenzymes, even though its role in contributing to cAMP binding and the interface between the two CNB domains is unique in each R-subunit. Figure 8 summarizes the different motifs that contribute to the interface and also indicates which are conserved and which are isoform specific.

Overall Conclusions

The CNB domain evolved as a major mechanism for both prokaryotes and eukaryotes to bind to small molecule second messengers in response to external stimuli such as nutrient deprivation. It is one of nature's classic allosteric proteins; while it is best known as a domain that binds cyclic nucleotides, other branches of this family bind to heme and very likely to other small molecules (Kannan et al., 2007). It is thus a general and versatile

Figure 8. Isoform Specific Interactions of Residues Conserved in Different R-Subunits

(A) Major interactions between CNB-A and CNB-B domains in Bcy1. PBC of the CNB-A domain is shown in red, α B/ α C helix in teal, 3₁₀ loop of CNB-B domain in tan. Holoenzyme conformation of the α B/ α C helix in RI α holoenzyme is shown as a gray transparent helix. Yellow arrows highlight the interactions between the 3₁₀ loop to PBC in CNB-A and the 3₁₀ loop to α B/ α C helix in CNB-B, respectively.

(B) Sequence alignment of the linker region between CNB-A and CNB-B domains in RI α , RII β , and Bcy1. The conserved residues are shaded gray. Arrows indicate salt bridges and hydrogen bonds formed by the conserved residues. Capping residues are shaded yellow.

Another Bcy1-specific feature is the way that the α A^B helix interacts with the conserved tyrosine (Tyr254^{Bcy1}) from the PBC^A. In RI α , Tyr205^{RI} was solvent exposed, whereas in RII β , the equivalent Tyr226^{RII} formed hydrogen bond interactions with the conserved Asp288^{RII} from α A^B, and a water molecule that hydrogen-bonds with the cAMP capping residue (Figure 5). In contrast, for Bcy1 the corresponding Tyr254^{Bcy1} is buried in a hydrophobic shell formed by residues from both CNB-A and CNB-B domains (Figure 6). Arg311, which also lies in the α A^B helix, contributes in a major way to this pocket where it inserts between Met253 and Tyr254, adjacent residues in the PBC. Although the mechanism by

sensor domain. In eukaryotes two contiguous CNB domains have been linked to protein phosphorylation in PKA and PKG. These cyclic nucleotide-regulated kinases are wide spread in fungi and all higher eukaryotes. In addition, they are found in symbiotic pathogens such as plasmodia where they appear to regulate transporters (Merckx et al., 2009). The structure of Bcy1 shows how these versatile allosteric domains cooperate in different ways to create a complex interdomain interface that recruits Bcy1 away from the catalytic subunit. Bcy1 also appears to be a hybrid between mammalian RI and RII subunits. Like RII subunits, it is phosphorylated at its inhibitory site, but in terms of the allosteric interface between the CNB-A and CNB-B domains it more closely resembles RI.

EXPERIMENTAL PROCEDURES

Protein Preparation

Construction of the proteolytically stable Bcy1(168–416) was generated by PCR cloning into the pRsetB vector (Invitrogen) between the NdeI and XhoI restriction sites. The protein was overexpressed in *Escherichia coli* strain BL21-CodonPlus(DE3)-RIPL (Stratagene) and purified as described previously (Su et al., 1995; Wu et al., 2004). In short, following overexpression, cells were lysed and clarified. After 60% ammonium sulfate precipitation, the pellet was resuspended and then bound to cAMP-Sepharose resin overnight, eluted with cAMP and then applied to a Superdex 75 column equilibrated with a buffer solution containing 50 mM MES (pH 5.8), 200 mM NaCl, 2 mM EDTA, 2 mM EGTA, 2 mM DTT. The protein was concentrated to 12 mg/ml using Amicon Ultra.

Crystallization and Data Collection

Crystals of Bcy1(168–416) were obtained from the reservoir solution (15% polyethylene glycol 3350, 0.1 M Tris-HCl [pH 8.0]) using the hanging drop vapor-diffusion method at 22.5°C. The crystals were then transferred to the cryoprotectant solution (mother liquor containing 20% glycerol) and flash cooled in liquid nitrogen. Initial crystal screening was carried out at the University of California, San Diego, chemistry home source at 100K before shipping to the ALS (Advanced Light Source, Berkeley, CA) for data collection. Ten data sets were collected at the ALS beamline 8.2.2 up to 2.2 Å resolution and then processed and scaled using HKL2000 (Otwinowski and Minor, 1997) to a space group of C2 with cell dimensions $a = 146.4 \text{ \AA}$, $b = 45.0 \text{ \AA}$, $c = 39.1 \text{ \AA}$, $\beta = 92.5^\circ$ (Table 1).

Structure Determination and Refinement

Initial phasing for Bcy1(168–416) was solved with the molecular replacement method in CNS (Crystallography and NMR System) (Brünger et al., 1998) by using the first cAMP-binding domain (residues 123–235) of the RI α (91–379) structure (pdb code: 1RGS) as the search model and then looking for two solutions. The final model was built in manually based on the density maps using the graphics software TURBO-FRODO (Roussel and Cambillau, 1991) and Coot (Emsley and Cowtan, 2004). The structure refinement was performed using both the CNS program and Refmac under CCP4 package (Murshudov et al., 1997). The final model was evaluated using PROCHECK (Laskowski et al., 1993) and had good geometry (Table 1) with all residues in the allowed region of the Ramachandran plot. Water molecules were built with the solvent building mode of wARP (Roussel and Cambillau, 1991) and checked individually.

CHAIN Analysis

CHAIN (contrast hierarchical alignment) analysis was performed as described previously (Neuwald, 2007) using two groups of R-subunit sequences: 40 sequences from fungi, and 65 sequences from mammals. The selected sequences are compiled in Table S1. The length of the sequences aligned and compared comprised the IS region, through both CNB domains (equivalent to residues 133–416 from Bcy1). This analysis focuses on finding sequence subgroups (fungal sequences in this case), which share a strikingly

conserved pattern but nonconserved in sequences outside of that subgroup (mammalian sequences in this case).

Phylogenetic Tree Construction

A phylogenetic tree was constructed based on the residue alignment of the cAMP binding domains of selected sequences of the PKA regulatory subunit taken from the alignment of Figure S2. The selection was performed in order to simplify the visualization of the tree by choosing a discrete number of sequences from each subphylum: 6 from *Ascomycota/Saccharomycotina*, 11 from *Ascomycota/Pezizomycotina*, 1 from *Ascomycota/Taphrinomycotina*, 4 from *Basidiomycota*, 4 from *Zygomycota*, 1 from *Blastocladiomycota*, and 4 from mammal, respectively. The tree was reconstructed using the neighbor-joining method (Saitou and Nei, 1987). The resulting tree was visualized with the program Treeview (Page, 1996).

ACCESSION NUMBERS

Coordinate and structure factor have been deposited in the Protein Data Bank with accession number of 3OF1.

SUPPLEMENTAL INFORMATION

Supplemental Information includes two figures and one table and can be found with this article online at doi:10.1016/j.str.2010.08.013.

ACKNOWLEDGMENTS

We specifically thank De-Bin Huang for assistance with the structure determination, Alexander Kornev for critical review and figure preparation, and Natarajan Kannan for helping with the CHAIN alignment. We also thank Nick Nyguen at the UCSD Chemistry X-ray source for assistance with data collection. J.R. held a doctoral fellowship from CONICET. This Investigation was supported by a NIH grant (GM34921) to S.S.T., and grants from ANPCYT (PICT 15-38212), UBACYT (X-151) and CONICET (PIP 0519) to S.M.

Received: July 13, 2010

Revised: August 16, 2010

Accepted: August 17, 2010

Published: November 9, 2010

REFERENCES

- Amieux, P.S., and McKnight, G.S. (2002). The essential role of RI alpha in the maintenance of regulated PKA activity. *Ann. N. Y. Acad. Sci.* 968, 75–95.
- Berman, H.M., Ten Eyck, L.F., Goodsell, D.S., Haste, N.M., Kornev, A., and Taylor, S.S. (2005). The cAMP binding domain: an ancient signaling module. *Proc. Natl. Acad. Sci. USA* 102, 45–50.
- Bhattacharyya, R., and Chakrabarti, P. (2003). Stereospecific interactions of proline residues in protein structures and complexes. *J. Mol. Biol.* 331, 925–940.
- Brown, S.H., Wu, J., Kim, C., Alberto, K., and Taylor, S.S. (2009). Novel isoform-specific interfaces revealed by PKA RIIbeta holoenzyme structures. *J. Mol. Biol.* 393, 1070–1082.
- Brünger, A.T., Adams, P.D., Clore, G.M., DeLano, W.L., Gros, P., Grosse-Kunstleve, R.W., Jiang, J.S., Kuszewski, J., Nilges, M., Pannu, N.S., et al. (1998). Crystallography & NMR system: a new software suite for macromolecular structure determination. *Acta Crystallogr. D Biol. Crystallogr.* 54, 905–921.
- Canaves, J.M., and Taylor, S.S. (2002). Classification and phylogenetic analysis of the cAMP-dependent protein kinase regulatory subunit family. *J. Mol. Evol.* 54, 17–29.
- Das, R., Esposito, V., Abu-Abed, M., Anand, G.S., Taylor, S.S., and Melacini, G. (2007). cAMP activation of PKA defines an ancient signaling mechanism. *Proc. Natl. Acad. Sci. USA* 104, 93–98.
- Diller, T.C., Madhusudan, Xuong, N.H., and Taylor, S.S. (2001). Molecular basis for regulatory subunit diversity in cAMP-dependent protein kinase: crystal structure of the type II beta regulatory subunit. *Structure* 9, 73–82.

- Emsley, P., and Cowtan, K. (2004). Coot: model-building tools for molecular graphics. *Acta Crystallogr. D Biol. Crystallogr.* **60**, 2126–2132.
- Griffioen, G., and Thevelein, J.M. (2002). Molecular mechanisms controlling the localization of protein kinase A. *Curr. Genet.* **41**, 199–207.
- Johnson, K.E., Cameron, S., Toda, T., Wigler, M., and Zoller, M.J. (1987). Expression in *Escherichia coli* of BCY1, the regulatory subunit of cyclic AMP-dependent protein kinase from *Saccharomyces cerevisiae*. Purification and characterization. *J. Biol. Chem.* **262**, 8636–8642.
- Kannan, N., Wu, J., Anand, G.S., Yooseph, S., Neuwald, A.F., Venter, J.C., and Taylor, S.S. (2007). Evolution of allostery in the cyclic nucleotide binding module. *Genome Biol.* **8**, R264.
- Kim, C., Cheng, C.Y., Saldanha, S.A., and Taylor, S.S. (2007). PKA-I holoenzyme structure reveals a mechanism for cAMP-dependent activation. *Cell* **130**, 1032–1043.
- Kim, C., Xuong, N.H., and Taylor, S.S. (2005). Crystal structure of a complex between the catalytic and regulatory (R1alpha) subunits of PKA. *Science* **307**, 690–696.
- Kornev, A.P., Taylor, S.S., and Ten Eyck, L.F. (2008). A generalized allosteric mechanism for cis-regulated cyclic nucleotide binding domains. *PLoS Comput. Biol.* **4**, e1000056. [10.1371/journal.pcbi.1000056](https://doi.org/10.1371/journal.pcbi.1000056).
- Kuret, J., Johnson, K.E., Nicolette, C., and Zoller, M.J. (1988). Mutagenesis of the regulatory subunit of yeast cAMP-dependent protein kinase. Isolation of site-directed mutants with altered binding affinity for catalytic subunit. *J. Biol. Chem.* **263**, 9149–9154.
- Laskowski, R.A., MacArthur, M.W., Moss, D.S., and Thornton, J.M. (1993). PROCHECK: a program to check the stereochemical quality of protein structures. *J. Appl. Cryst.* **26**, 283–291.
- McNicholl, E.T., Das, R., SilDas, S., Taylor, S.S., and Melacini, G. (2010). Communication between tandem cAMP binding domains in the regulatory subunit of protein kinase A-alpha as revealed by domain-silencing mutations. *J. Biol. Chem.* **285**, 15523–15537.
- Merckx, A., Bouyer, G., Thomas, S.L., Langsley, G., and Egée, S. (2009). Anion channels in *Plasmodium falciparum*-infected erythrocytes and protein kinase A. *Trends Parasitol.* **25**, 139–144.
- Murshudov, G.N., Vagin, A.A., and Dodson, E.J. (1997). Refinement of macromolecular structures by the maximum-likelihood method. *Acta Crystallogr. D Biol. Crystallogr.* **53**, 240–255.
- Neuwald, A.F. (2007). The CHAIN program: forging evolutionary links to underlying mechanisms. *Trends Biochem. Sci.* **32**, 487–493.
- Ocampo, J., Fernandez Nuñez, L., Silva, F., Pereyra, E., Moreno, S., Garre, V., and Rossi, S. (2009). A subunit of protein kinase A regulates growth and differentiation in the fungus *Mucor circinelloides*. *Eukaryot. Cell* **8**, 933–944.
- Otwinowski, Z., and Minor, W. (1997). Processing of X-ray diffraction data collected in oscillation mode. *Methods Enzymol.* **276**, 307–326.
- Page, R.D.M. (1996). TREEVIEW: An application to display phylogenetic trees on personal computers. *CABIOS* **12**, 357–358.
- Portela, P., Zaremberg, V., and Moreno, S. (2001). Evaluation of in vivo activation of PKA under non-dissociable conditions through the overexpression of wild-type and mutant regulatory subunits in *Saccharomyces cerevisiae*. *Microbiology (SGM-UK)*, **147**, 1149–1159.
- Rehmann, H., Prakash, B., Wolf, E., Rueppel, A., de Rooij, J., Bos, J.L., and Wittinghofer, A. (2003). Structure and regulation of the cAMP-binding domains of Epac2. *Nat. Struct. Mol. Biol.* **10**, 26–32.
- Rehmann, H., Wittinghofer, A., and Bos, J.L. (2007). Capturing cyclic nucleotides in action: snapshots from crystallographic studies. *Nat. Rev. Mol. Cell Biol.* **8**, 63–73.
- Rolland, F., Winderickx, J., and Thevelein, J.M. (2002). Glucose-sensing and signalling mechanisms in yeast. *FEM. Yeast Res.* **2**, 183–201.
- Roussel, A., and Cambillau, C. (1991). Silicon Graphics Geometry Partners Directory. (Mountain View, CA: Silicon Graphics Inc.).
- Saitou, N., and Nei, M. (1987). The neighbor-joining method: A new method for reconstructing phylogenetic trees. *Mol. Biol. Evol.* **4**, 406–425.
- Santangelo, G.M. (2006). Glucose signaling in *Saccharomyces cerevisiae*. *Microbiol. Mol. Biol. Rev.* **70**, 253–282.
- Stajich, J.E., Berbee, M.L., Blackwell, M., Hibbett, D.S., James, T.Y., Spatafora, J.W., and Taylor, J.W. (2009). The fungi. *Curr. Biol.* **19**, R840–R845.
- Su, Y., Dostmann, W.R., Herberg, F.W., Durick, K., Xuong, N.H., Ten Eyck, L., Taylor, S.S., and Varughese, K.I. (1995). Regulatory subunit of protein kinase A: structure of deletion mutant with cAMP binding domains. *Science* **269**, 807–813.
- Taylor, S.S., Buechler, J.A., and Yonemoto, W. (1990). cAMP dependent protein kinase: framework for a diverse family of regulatory enzymes. *Annu. Rev. Biochem.* **59**, 971–1005.
- Taylor, S.S., Kim, C., Cheng, C.Y., Brown, S.H.J., Wu, J., and Kannan, N. (2008). Signaling through cAMP and cAMP-dependent protein kinase: diverse strategies for drug design. *Biochim. Biophys. Acta* **1784**, 16–26.
- Toda, T., Cameron, S., Sass, S., Zoller, M., Scott, J.D., McMullen, B., Hurwitz, M., Krebs, E.G., and Wigler, M. (1987a). Cloning and characterization of BCY1, a locus encoding a regulatory subunit of the cyclic AMP-dependent protein kinase in *Saccharomyces cerevisiae*. *Mol. Cell Biol.* **7**, 1371–1377.
- Toda, T., Cameron, S., Sass, P., Zoller, M., and Wigler, M. (1987b). Three different genes in *S.cerevisiae* encode the catalytic subunits of the cAMP-dependent protein kinase. *Cell* **50**, 277–287.
- Tudisca, V., Recouvreur, V., Moreno, S., Boy-Marcotte, E., Jacquet, M., and Portela, P. (2010). Differential localization to cytoplasm, nucleus or P-bodies of yeast PKA subunits under different growth conditions. *Eur. J. Cell Biol.* **89**, 339–348.
- Weber, I.T., and Steitz, T.A. (1987). Structure of a complex of catabolite gene activator protein and cyclic AMP refined at 2.5 Å resolution. *J. Mol. Biol.* **198**, 311–326.
- Wu, J., Jones, J.M., Nguyen-Huu, X., Ten Eyck, L.F., and Taylor, S.S. (2004). Crystal structures of R1alpha subunit of cyclic adenosine 5'-monophosphate (cAMP)-dependent protein kinase complexed with (Rp)-adenosine 3',5'-cyclic monophosphothioate and (Sp)-adenosine 3',5'-cyclic monophosphothioate, the phosphothioate analogues of cAMP. *Biochemistry* **43**, 6620–6629.
- Wu, J., Brown, S.H., von Daake, S., and Taylor, S.S. (2007). PKA type II alpha holoenzyme reveals a combinatorial strategy for isoform diversity. *Science* **318**, 274–279.
- Zagotta, W.N., Olivier, N.B., Black, K.D., Young, E.C., Olson, R., and Gouaux, E. (2003). Structural basis for modulation and agonist specificity of HCN pacemaker channels. *Nature* **425**, 200–205.